

DESIGN,  
MADE AND QUALITY  
IN ITALY  
100%

**fm** MAURI



Beschlaege fuer Moebel D.I.Y.



Moebelbeschlaege



Zubehoere fuer HI-FI Moebel

Beschlaege fuer Sofa



Katalog Beschlaege fuer Moebel

# Moebelbeschlaege

## Regulierfuesse

- **Art. 300G0** Regulierfuesse
- **Art. 30110** Regulierfuesse
- **Art. 301G0** Regulierfuesse
- **Art. 30410** Regulierfuesse
- **Art. 304G0** Regulierfuesse
- **Art. 720G0** Regulierfuesse

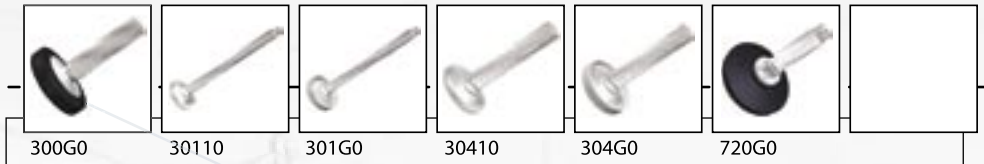

Beispiel der Montage  
von Art.720G0  
Regulierfuss durch  
Art.566 L- Inbusschluessel



Tisch mit Regulierfuss  
Art. 300G0



## Moebelverbinder



- **Art. 30500** Bohrung 30
- **Art. 51200** Bohrung 30
- **Art. 62700** Bohrung 30
- **Art. 66000** Bohrung 35
- **Art. 665G0** Bohrung 35
- **Art. 665A0** Bohrung 35
- **Art. 665C4** Vierkantschraube M6
- **Art. 250G0** Bohrung 35
- **Art. 50401** Bohrung 40
- **Art. 555C4** Bohrung 8
- **Art. 565H1** Bohrung 5

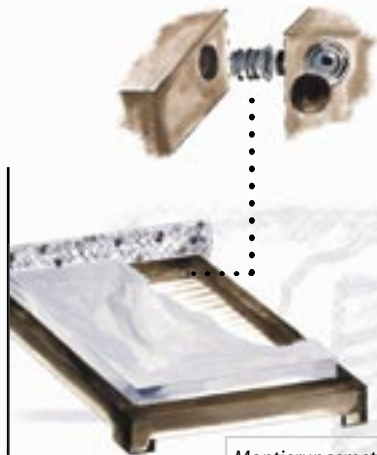

Montierungsmethode  
des Art.250G0, fuer  
Bettmontage

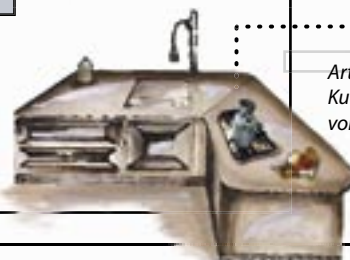
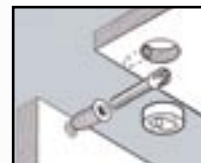
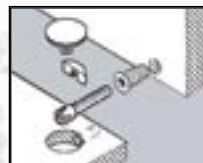
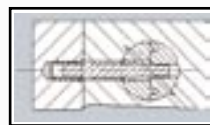

Art. 665G0 fuer die  
Kuechearbeitenplatten  
vorgestellt

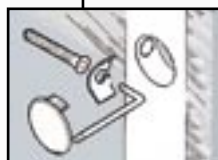

# Beschlaege fuer Moebel D.I.Y.

## Muffen, Schrauben und Huelsenmutter

- **Art. 312A0** Muffen
- **Art. 313A0** Muffen
- **Art. 416A0** Verbindungsschrauben
- **Art. 433A0** Verbindungsschrauben
- **Art. 553A0** Verbindungsschrauben
- **Art. 470A0** Verbindungsschrauben
- **Art. 657A0** Verbindungsschrauben
- **Art. 563A0** Huelsenmutter
- **Art. 564A0** Huelsenmutter
- **Art. 615A0** Huelsenmutter



Schraube und Huelsenmutter



Verbindungsschraube und Gewindemuffe

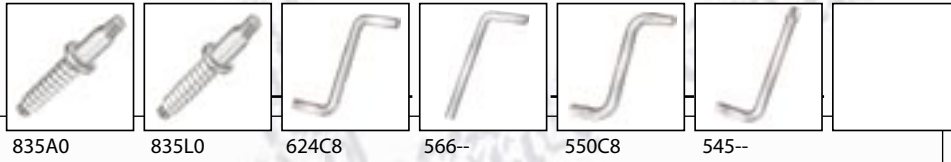
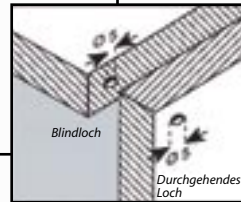

## DIY-Stuehle und Schluessel

- **Art. 835A0** Stockschrauben
- **Art. 835L0** Stockschrauben
- **Art. 624C8** Z-Inbusschluessel
- **Art. 566--** L-Inbusschluessel
- **Art. 550C8** Z-Inbusschluessel
- **Art. 545--** L-Schluessel

Stockschrauben Art.835A0 und Art. 835L0

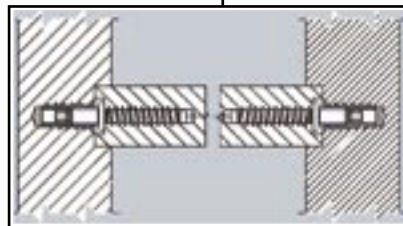

Schluessel mit Inbus und Pzd Schlitz

# Zubehoere fuer HI-FI Moebel

## Druckmagnet Schnaepper

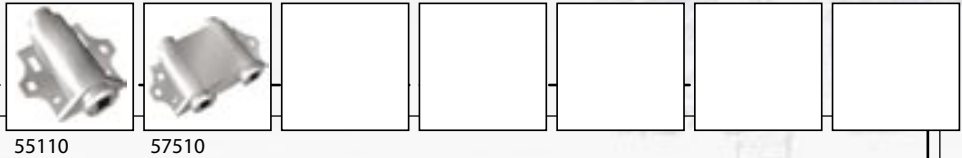

55110

57510

- **Art. 551** Druckmagnet Schnaepper
- **Art. 575** Druckmagnet Schnaepper, doppelt



Verschluss mit doppeltem Druckmagnetschnaepper

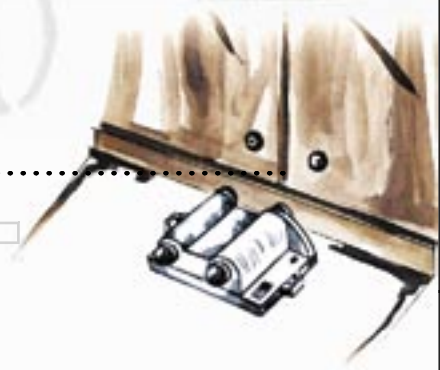

Verschluss mit Druckmagnetschnaepper



## Gegenplatte fuer Glastueren

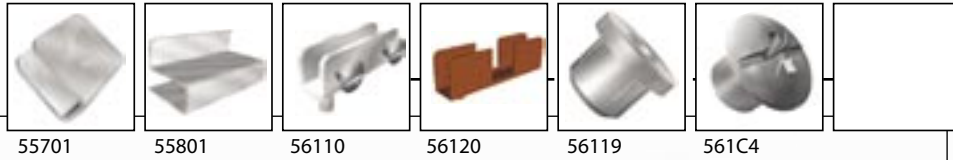

55701

55801

56110

56120

56119

561C4

- **Art. 55701** Gegenplatte
- **Art. 55801** Griff fuer Glastueren
- **Art. 56110** Kit Zapfenband
- **Art. 56120** Kit Zapfenband
- **Art. 56119** Kit Zapfenband
- **Art. 561C4** Kit Zapfenband



Gegenplatte mit oder ohne Griff fuer Glastueren



Zapfenband fuer Glastueren

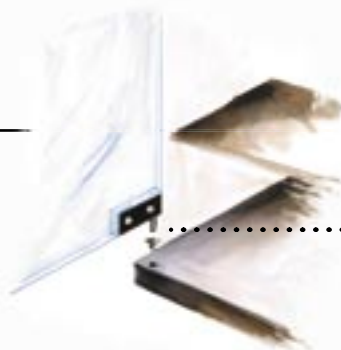

# Beschlaege fuer Sofa

## Bettbeschlag

- **Art. 50703** Bettbeschlaeg, maennlichsteil
- **Art. 50704** Bettbeschlaeg, weiblichsteil
- **Art. 20103** Bettbeschlaeg, maennlichsteil
- **Art. 20104** Bettbeschlaeg, weiblichsteil



Beschlaege fuer Bett



## Niete



- **Art. 690A0** Niete
- **Art. 412A0** Schrankschraube
- **Art. 318F5** Muffe M10, Linksgewinde
- **Art. 318L2** Muffe M6, Linksgewinde



Muffe Art.318F5 und Schrankschraube Art.412



Art.690 im Lehnstuhlrahmen eingefast





**MAURI**  
**F.lli Mauri srl**

Via Barzago, 189  
23852 Garlate (LC) Italy  
Tel. +39 0341 681475  
Fax +39 0341 681483  
[www.mauri-fm.it](http://www.mauri-fm.it)  
[sales@mauri-fm.it](mailto:sales@mauri-fm.it)

**Furniture Fittings Factory**  
**Viteria speciale per mobili**

Cap. Soc. € 500.000 Int. Vers  
Iscriz. Trib.n. 3507 Reg. Soc.  
N.Centro Mecc. LC 000250  
C.C.I.A.A. Lecco N. 68980  
P.IVA IT 00204050132

