

DESIGN,
MADE AND QUALITY
IN ITALY
100%

fm MAURI



Quincaillerie pour meubles D.I.Y.



Quincaillerie pour meubles



Quincaillerie pour meubles HI-FI



Quincaillerie pour divan

Catalogue quincaillerie pour meubles

Quincaillerie pour meubles

Vérins

- Art. 300G0 vérins
- Art. 30110 vérins
- Art. 301G0 vérins
- Art. 30410 vérins
- Art. 304G0 vérins
- Art. 720G0 vérins

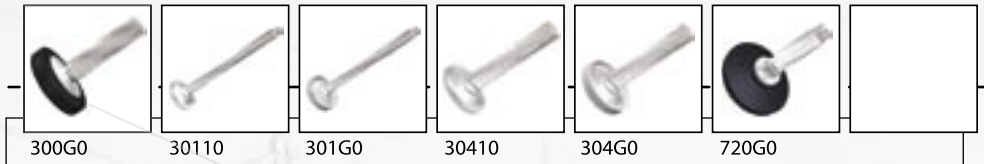

Exemple d'assemblage du vérin art. 720G0 par l'art. 566 clé "L"



Table avec vérin Art. 300G0



Vis à relieur

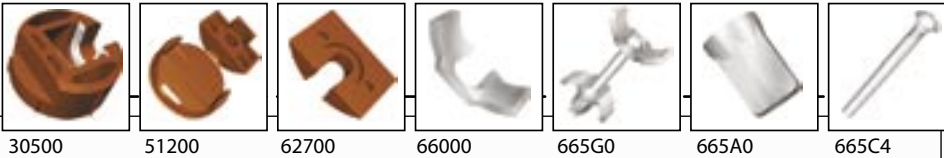

- Art. 30500 trou 30
- Art. 51200 trou 30
- Art. 62700 trou 30
- Art. 66000 trou 35
- Art. 665G0 trou 35
- Art. 665A0 trou 35
- Art. 665C4 vis tb M6 avec collet carré
- Art. 250G0 trou 35
- Art. 50401 trou 40
- Art. 555C4 trou 8
- Art. 565H1 trou 5

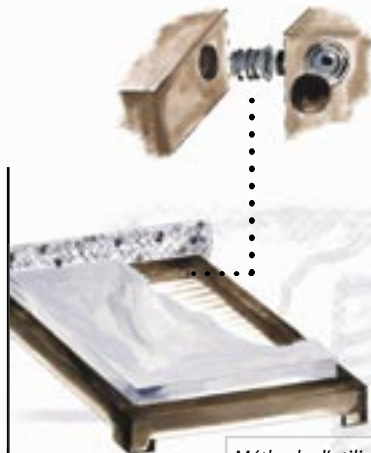

Méthode d'utilisation art. 250G0 pour l'assemblage de lits

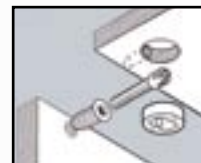
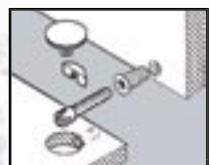
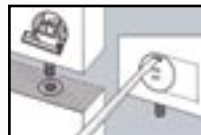
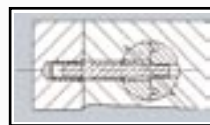

Art. 665G0 étudié pour assembler les plateaux de travail des cuisines

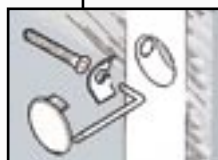
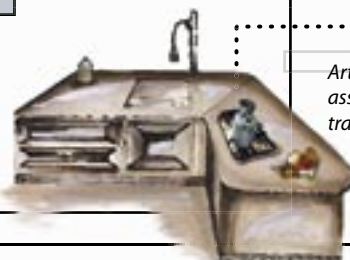

Quincaillerie pour meubles D.I.Y.

Écrous, vis et écrous borgne

- **Art. 312A0** Écrous
- **Art. 313A0** Écrous
- **Art. 416A0** Vis assemblage
- **Art. 433A0** Vis assemblage
- **Art. 553A0** Vis assemblage
- **Art. 470A0** Vis assemblage
- **Art. 657A0** Vis assemblage
- **Art. 563A0** Écrous borgne
- **Art. 564A0** Écrous borgne
- **Art. 615A0** Écrous borgne

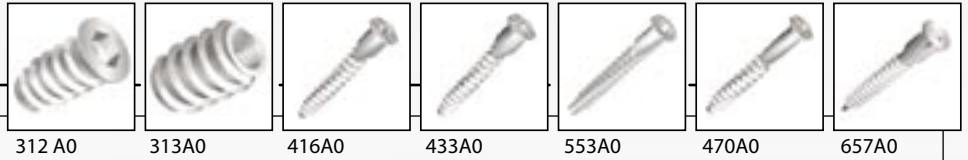

Vis et écrou borgne



Vis assemblage
et écrou fileté

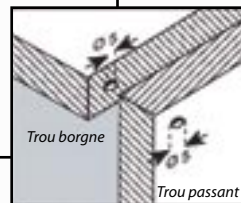

Trou borgne

Trou passant

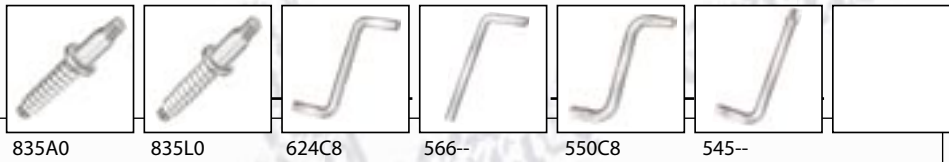

DIY-Chaises et clés hex.

- **Art. 835A0** Vis double filet
- **Art. 835L0** Vis double filet
- **Art. 624C8** Clés hex. "Z"
- **Art. 566--** Clés hex. "L"
- **Art. 550C8** Clés hex. "Z"
- **Art. 545--** Clé L

Vis double filet art. 835A0
et art. 835L0

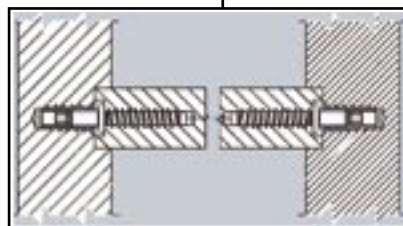

Clés avec hexagon
et empreinte pzd



Quincaillerie pour meubles HI-FI

Loqueteaux magnétiques

- **Art. 551** Loqueteau magnétique simple
- **Art. 575** Loqueteau magnétique double

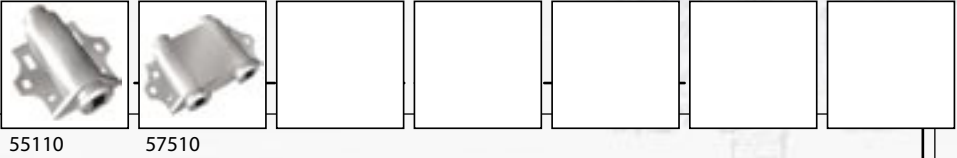

Fermeture par loqueteau magnétique simple

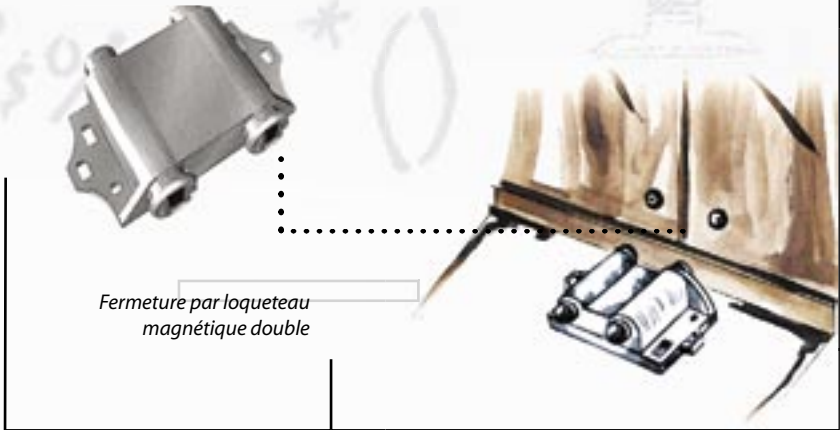

Fermeture par loqueteau magnétique double

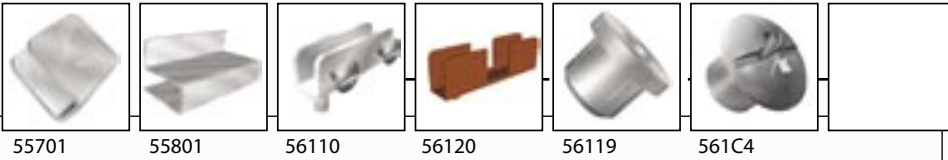

Cavaliers

- **Art. 55701** Cavaliers
- **Art. 55801** Poignées pour vitres
- **Art. 56110** Kit de pivots
- **Art. 56120** Kit de pivots
- **Art. 56119** Kit de pivots
- **Art. 561C4** Kit de pivots



Cavaliers avec ou sans poignées pour vitres



Pivot pour vitres

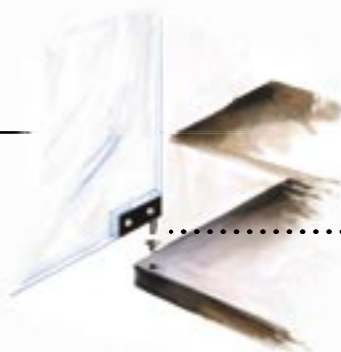

Quincaillerie pour divan

Glissière pour lit

- **Art. 50703** glissière, seulement male
- **Art. 50704** glissière, seulement femelle
- **Art. 20103** glissière, seulement male
- **Art. 20104** glissière, seulement femelle



Quincaillerie pour lits



Rivets



- **Art. 690A0** rivet hex.
- **Art. 412A0** vis tête hex.
- **Art. 318F5** écrou M10, filet gauche
- **Art. 318L2** écrou M6, filet gauche



Écrou art.318F5 et vis tête hex.art.412



Art.690 encastré dans le châssis d'un fauteuil





MAURI
F.lli Mauri srl

Via Barzago, 189
23852 Garlate (LC) Italy
Tel. +39 0341 681475
Fax +39 0341 681483
www.mauri-fm.it
sales@mauri-fm.it

Furniture Fittings Factory
Viteria speciale per mobili

Cap. Soc. € 500.000 Int. Vers
Iscriz. Trib.n. 3507 Reg. Soc.
N.Centro Mecc. LC 000250
C.C.I.A.A. Lecco N. 68980
P.IVA IT 00204050132

